

8900 SPA/SPAT/SPAK - ABP

Super parallel arm mount
and advanced back plate (ABP89)

Installation instructions

08279721 – 09-2019

| EN |

dormakaba 

Table of contents



1	Technical specifications	3
1.1	Overview	3
1.2	Tools recommended	3
1.3	Handing the door	3
2	Instructions - parallel mount	4
2.1	Installing surface closer and drop plate	4
2.2	Secure soffit plate to frame: spacer block, blade stop, or narrow frame bracket	4
2.3	Securing main arm to closer	5
3	Adjustments	6
3.1	Adjust closing speeds: sweep, latch, backcheck, delayed action	6
3.2	Adjust hold open (optional)	6
3.3	Adjust spring force	7
4	Install covers	7

1 Technical specifications

1.1 Overview

-  Caution: sex nuts are required for attachment of components to unreinforced doors and to wood or plastic faced composite type fire doors, unless an alternative method is identified in the individual door manufacturer's listings.

 Maximum door opening degree is 180°.

 Arrow on backplate points downward.
-  Hold open range is from 85° to 110° with optional hold open kit.

 Know the swing of the door which is being installed prior to installation.

 Verify closer spring size prior to installation.

 Make sure door efficiently operates prior to installing closer.

1.2 Tools recommended

Table 1

Drill bits:	#3 Phillips screwdriver
Metal: 7/32" drill bit; 1/4-20 tap	3/16" flat head screwdriver
Wood: 3/8" and 5/32" bit	5mm hex key
1/2" box wrench	

1.3 Handing the door

Fig.1

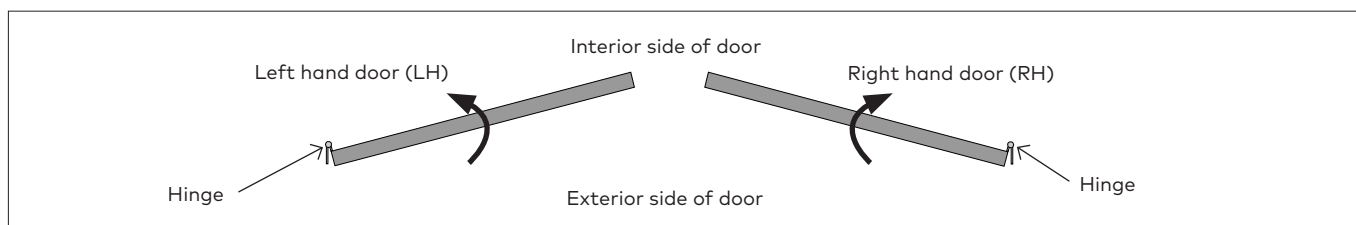

2 Instructions - parallel mount

2.1 Installing surface closer and drop plate

Fig.2

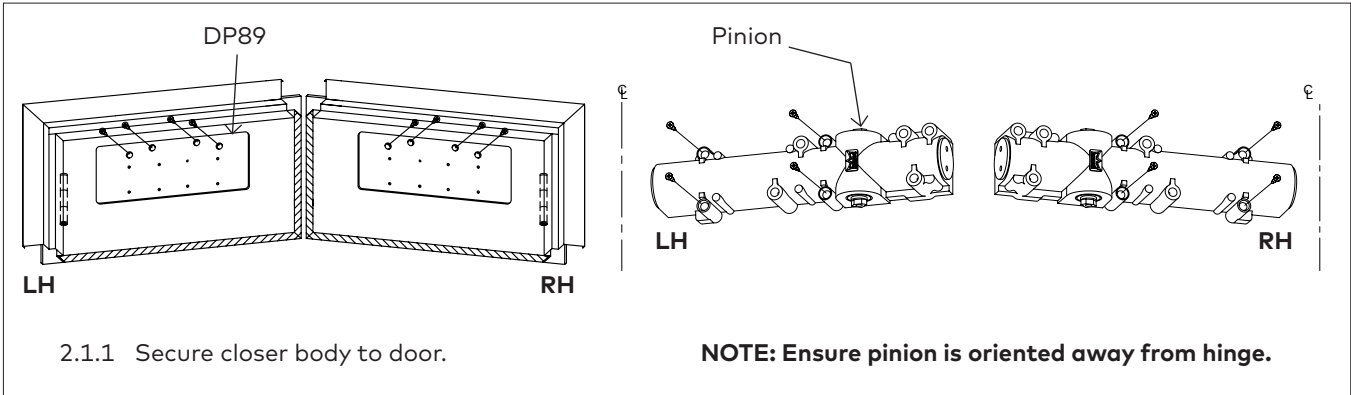

2.2 Secure soffit plate to frame: spacer block, blade stop, or narrow frame bracket

Fig.3

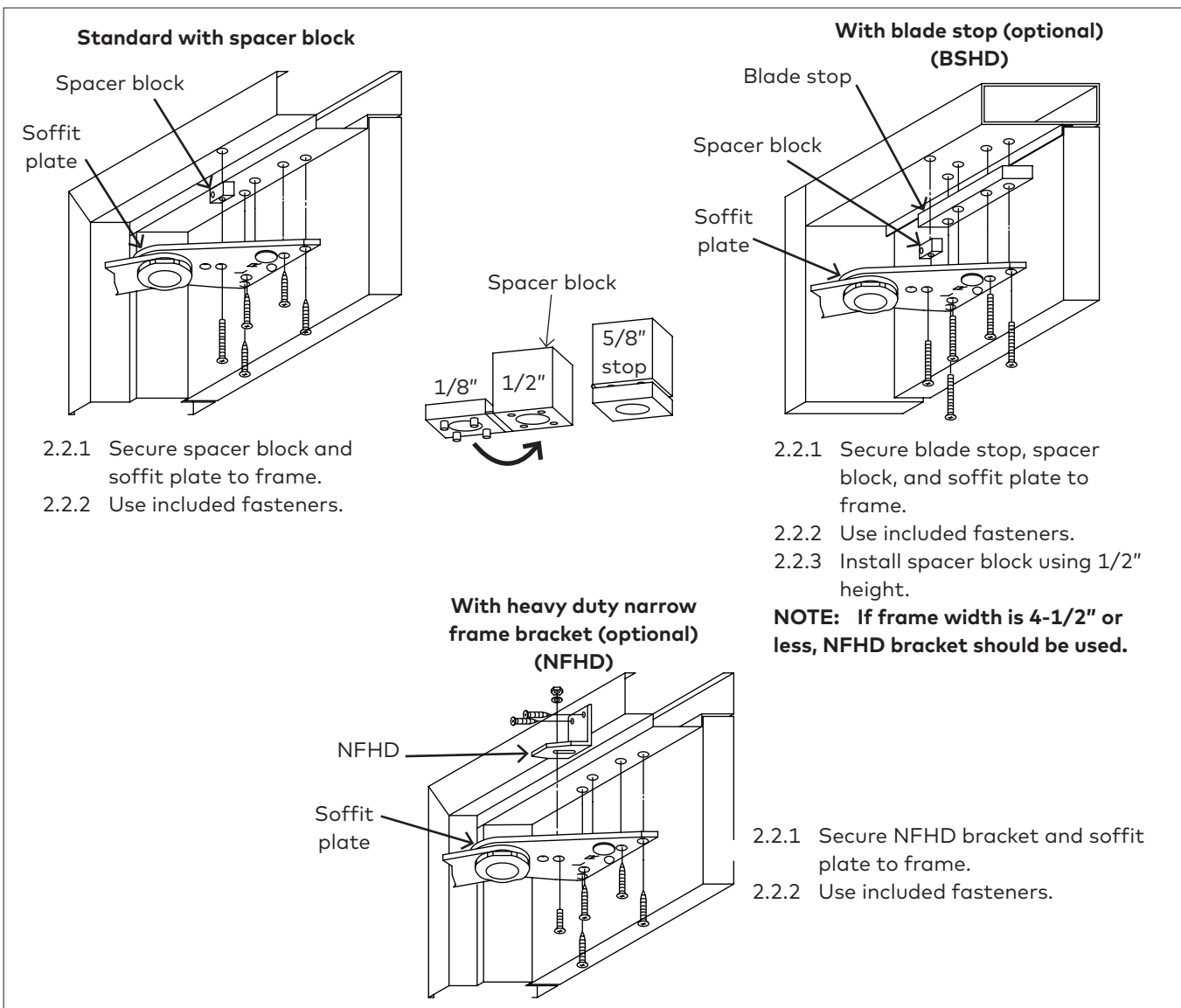



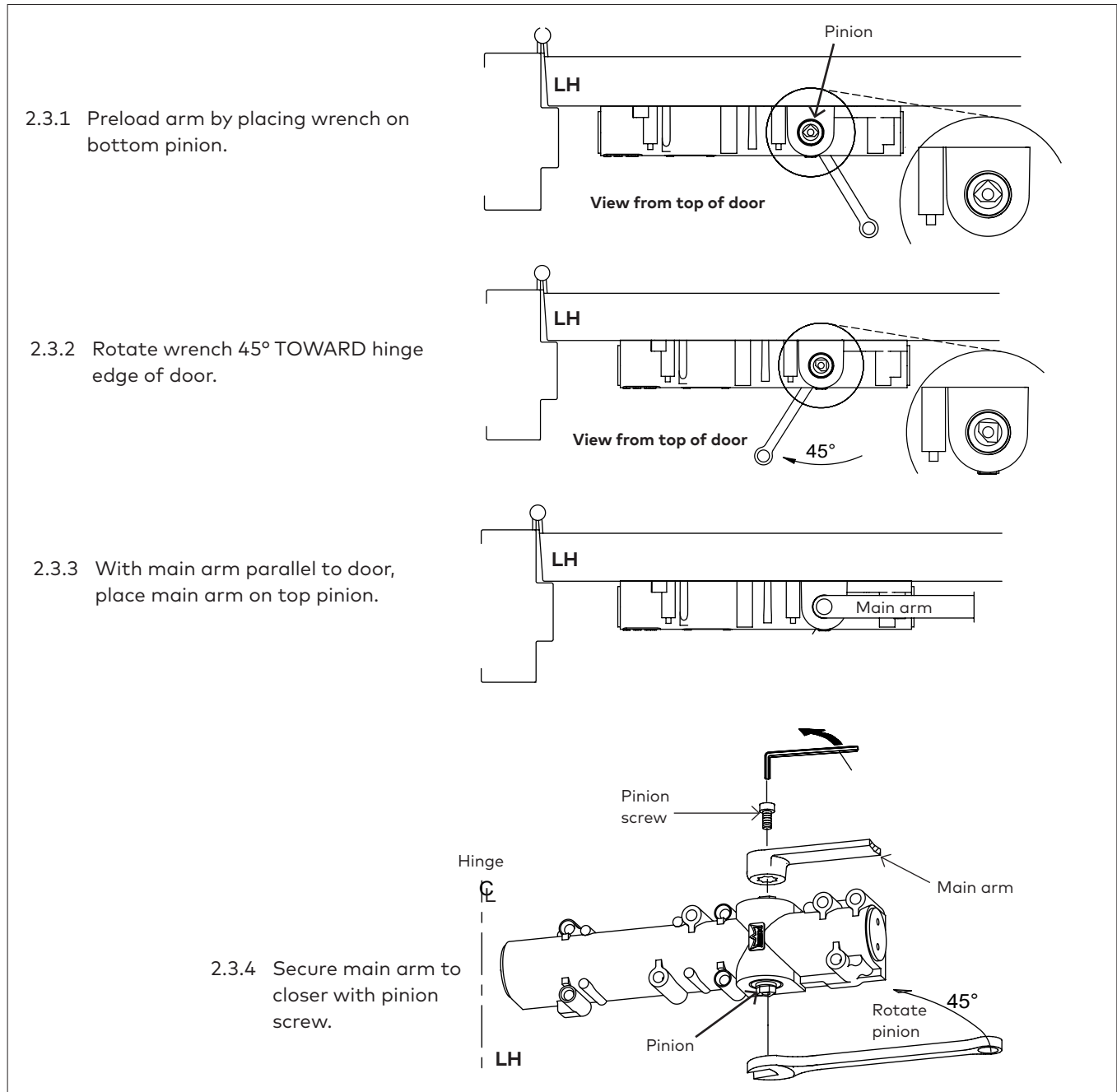

2.3 Securing main arm to closer

Fig.4



3 Adjustments

-  Confirm closer spring size prior to making any closing speed adjustments.
-  Do not back valve heads out beyond closer casting.

-  Maximum opening angle is 180°.
-  Door should close in 3 to 6 seconds from 90°.
-  Do not close valves completely.

3.1 Adjust closing speeds: sweep, latch, backcheck, delayed action

Fig.5

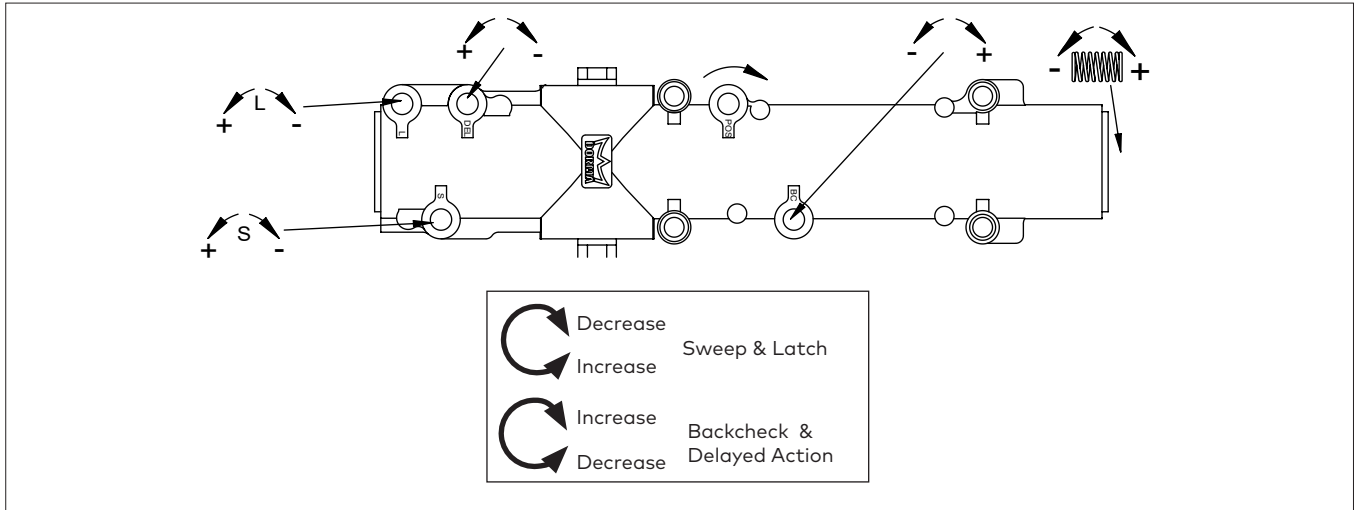

- 3.1.1 Adjust **closing sweep speed**: 90° to start of latch speed.
- Increase sweep speed: Turn valve counter-clockwise
 - Decrease sweep speed: Turn valve clockwise.
- 3.1.2 Adjust **closing latch speed**: 15° to close.
- Increase latch speed: Turn valve counter-clockwise

- 3.1.3 Adjust **opening backcheck**: beginning at 60°.
- Increase resistance: Turn valve clockwise
 - Decrease resistance: Turn valve counter-clockwise.
- 3.1.4 Adjust **closing delayed action**: beginning at 180°.
- Increase delayed action: Turn valve clockwise
 - Decrease delayed action: Turn valve counter-clockwise

3.2 Adjust hold open (optional)

Fig.6

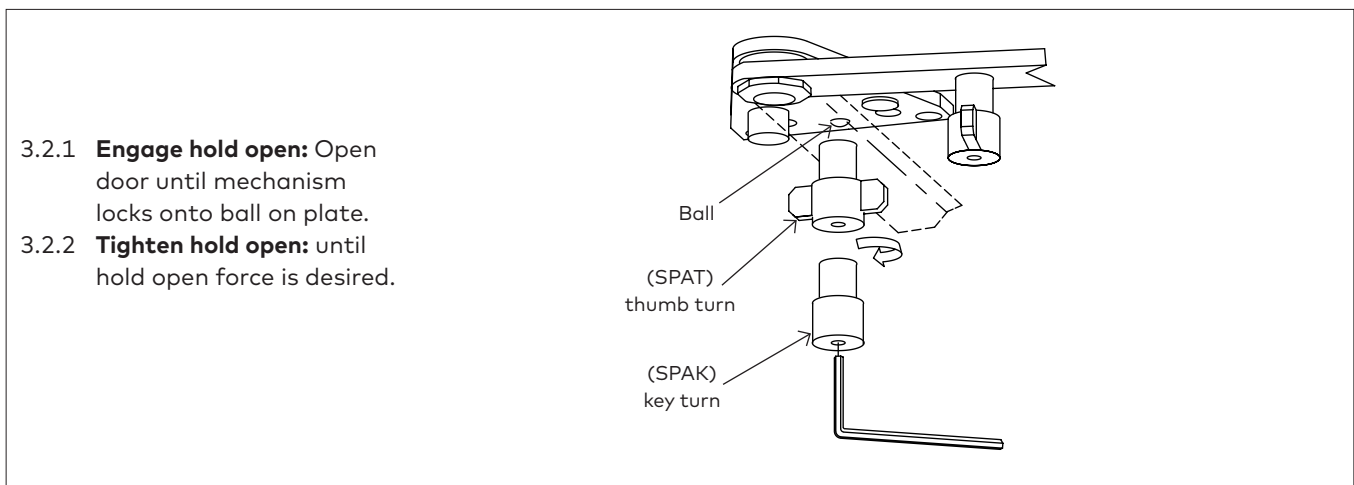

3.3 Adjust spring force

Fig.7

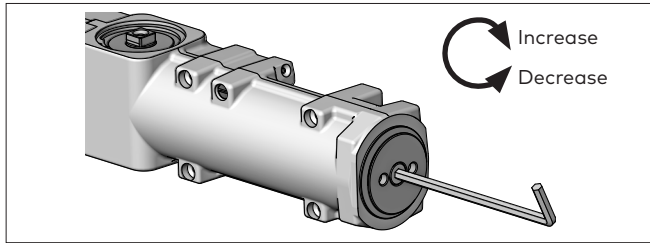

8916 - supplied with a size 4
8956 - supplied with a size 6

8916 ONLY - Barrier free openings: Take an opening force reading from the pull on the door. If required, adjust the spring force to meet the barrier-free requirement.

- **Decrease force:** turn counter-clockwise; 8 turns max.
- **Increase force:** turn clockwise; 14 turns max.

Depending on opening conditions, a door adjusted to meet barrier-free forces may not have sufficient power to reliably close and latch the door.

Parallel mount					
	Closer size	Max door weight (lbs)	Door width		Full turns
			Interior	Exterior	
8916	3	100	2'-6"	---	-12
	4	125	3'	2'6"	0
	5	150	3'6"	3'	+4
	6	200	4'	3'6"	+12
8956	5	150	3'6"	3'	-6
	6	200	4'	3'6"	0
	6+	250	---	4'	+6

4 Install covers

Fig.8

4.1.1 Place tab in cover slot, opposite main arm.

4.1.2 Place cover over closer and fasten securely with screws provided.

